

## INSTRUCTION MANUAL

# VHF AIR BAND TRANSCEIVER **IC-A4**

---

This device complies with Part 15 of the FCC Rules. Operation is subject to the condition that this device does not cause harmful interference.

---

**Icom Inc.**

---

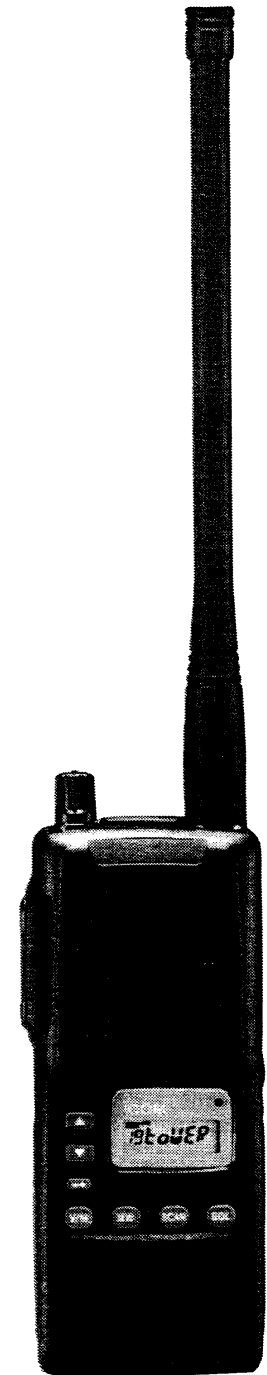

---

## FOREWORD

---

**READ ALL INSTRUCTIONS** carefully and completely before using the transceiver.

**SAVE THIS INSTRUCTION MANUAL** — This instruction manual contains important operating instructions for the IC-A4.

---

## EXPLICIT DEFINITIONS

---

The explicit definitions below apply to this instruction manual.

WORD	DEFINITION
<b>⚠ WARNING</b>	Personal injury, fire hazard or electric shock may occur.
<b>CAUTION</b>	Equipment damage may occur.
<b>NOTE</b>	If disregarded, inconvenience only. No risk of personal injury, fire or electric shock.

**FCC caution:** Changes or modifications to this transceiver, not expressly approved by Icom Inc., could void your authority to operate this transceiver under FCC regulations. -

---

## CAUTIONS

---

**⚠ WARNING! NEVER** hold the transceiver so that the antenna is very close to, or touching exposed parts of the body, especially the face or eyes, while transmitting. The transceiver will perform best if the microphone is 5 to 10 cm away from the lips and the transceiver is vertical.

**⚠ WARNING! NEVER** operate the transceiver with a headset or other audio accessories at high volume levels. Hearing experts advise against continuous high volume operation. If you experience a ringing in your ears, reduce the volume level or discontinue use.

**NEVER** connect the transceiver to an AC outlet or to a power source of more than 16 V DC. Such a connection will damage the transceiver.

**NEVER** connect the transceiver to a power source that is DC fused at more than 5 A. Accidental reverse connection will be protected by this fuse, higher fuse values will not give any protection against such accidents and the transceiver will be ruined.

**NEVER** attempt to charge alkaline or dry cell batteries. Beware that external DC power connections will charge batteries inside the battery case. This will damage not only the battery case but also the transceiver.

# SUPPLIED ACCESSORIES

**DO NOT** push the PTT when not actually desiring to transmit.

**DO NOT** allow children to play with any radio equipment containing a transmitter.

**DO NOT** operate the transceiver near unshielded electrical blasting caps or in an explosive atmosphere.

**AVOID** using or placing the transceiver in direct sunlight or in areas with temperatures below  $-10^{\circ}\text{C}$  or above  $+60^{\circ}\text{C}$ .

The use of non-Icom battery packs/chargers may impair transceiver performance and invalidate the warranty.

Even when the transceiver power is OFF, a slight current still flows in the circuits. Remove the battery pack or case from the transceiver when not using it for a long time. Otherwise, the battery pack or installed dry cell batteries will become exhausted.

Accessories included with the transceiver:	Qty.
① Antenna .....	1
② Belt clip .....	1
③ Handstrap.....	1
④ Battery pack or battery case with Ni-Cd batteries .....	1
⑤ Wall charger* .....	1

\*The battery pack (BP-195) or battery case may differ depending on version. Some versions do not include a battery pack and wall charger.

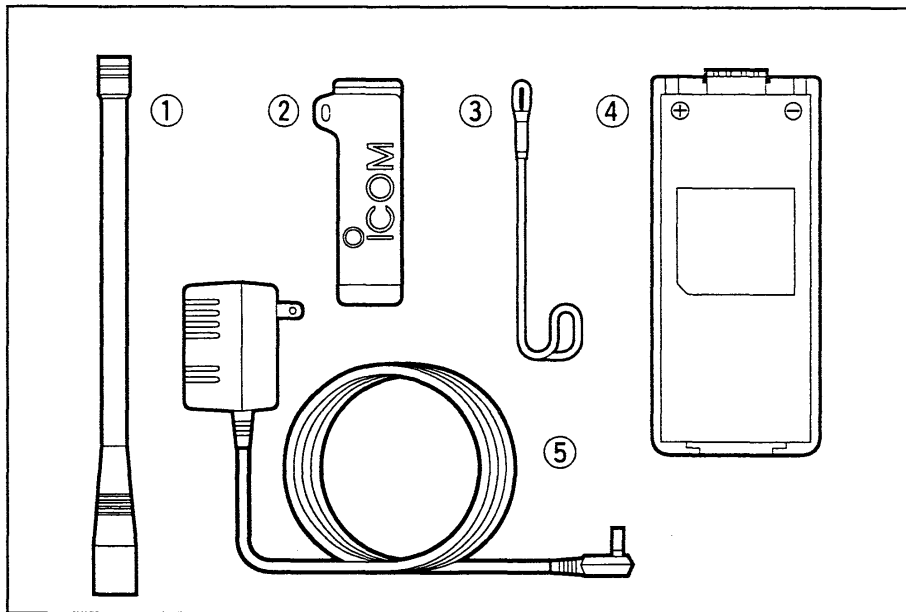

---

# TABLE OF CONTENTS

---

FOREWORD .....	i	■ Programming a memory channel .....	9
EXPLICIT DEFINITIONS .....	i	■ Memory names .....	10
CAUTIONS .....	i	<b>6 OTHER FUNCTIONS .....</b>	<b>11</b>
SUPPLIED ACCESSORIES.....	ii	■ Initial set mode .....	11
TABLE OF CONTENTS .....	iii	■ Resetting the CPU .....	11
<b>1 ACCESSORY ATTACHMENT .....</b>	<b>1</b>	<b>7 BATTERY PACKS .....</b>	<b>12–14</b>
<b>2 PANEL DESCRIPTION .....</b>	<b>2–4</b>	■ Charging precautions .....	12
■ Panel description .....	2–3	■ Battery pack charging .....	12
■ Function display .....	4	■ About the battery pack .....	14
<b>3 BASIC OPERATION .....</b>	<b>5–7</b>	■ Installing batteries in the battery case .....	14
■ Receiving and transmitting .....	5	<b>8 CLONING .....</b>	<b>15</b>
■ Setting squelch level .....	6	<b>9 TROUBLESHOOTING .....</b>	<b>16</b>
■ Side tone function .....	6	<b>10 SPECIFICATIONS .....</b>	<b>17</b>
■ Lock function .....	6	<b>11 OPTIONS .....</b>	<b>18</b>
■ Display backlighting .....	6		
■ Low battery indicator .....	6		
■ Dial select function .....	7		
<b>4 SCAN OPERATION .....</b>	<b>8</b>		
■ Memory (lockout) scan .....	8		
■ VFO (full) scan .....	8		
<b>5 MEMORY PROGRAMMING .....</b>	<b>9–10</b>		

# ACCESSORY ATTACHMENT

1

## ◇ Antenna

**CAUTION:** Transmitting without an antenna may damage the transceiver.

Insert the supplied antenna into the antenna connector and screw down the antenna as shown at right.

**Keep** the jack cover attached when jacks are not in use to avoid bad contacts from dust and moisture.

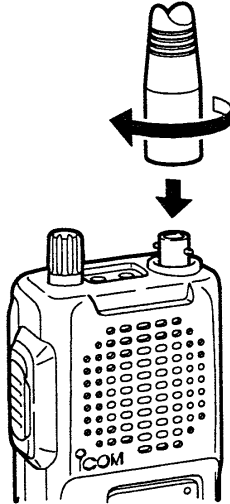

## ◇ Belt clip

Conveniently attaches to your belt.

*To attach:*

Slide the belt clip into the plastic loop on the back of the battery case/pack.

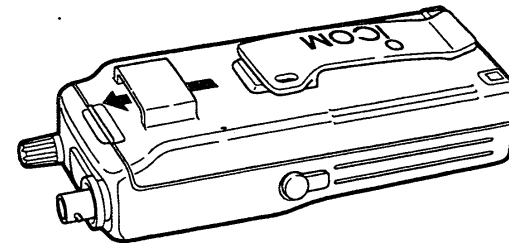

*To remove:*

Push the top of the belt clip towards the transceiver and at the same time, push it downward and free of the plastic loop.

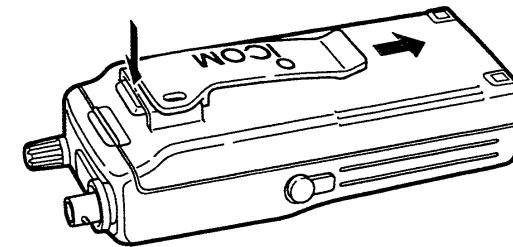

## ◇ Battery pack replacement

*To remove:*

Push and hold the battery release downwards, then pull the battery pack upwards as shown at right.

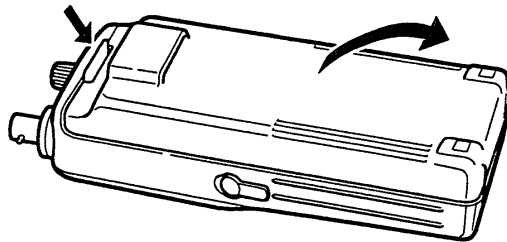

*To attach:*

Mate the notched ends of the battery pack and the transceiver, and push the battery pack until it clicks into place.

## ■ Panel description

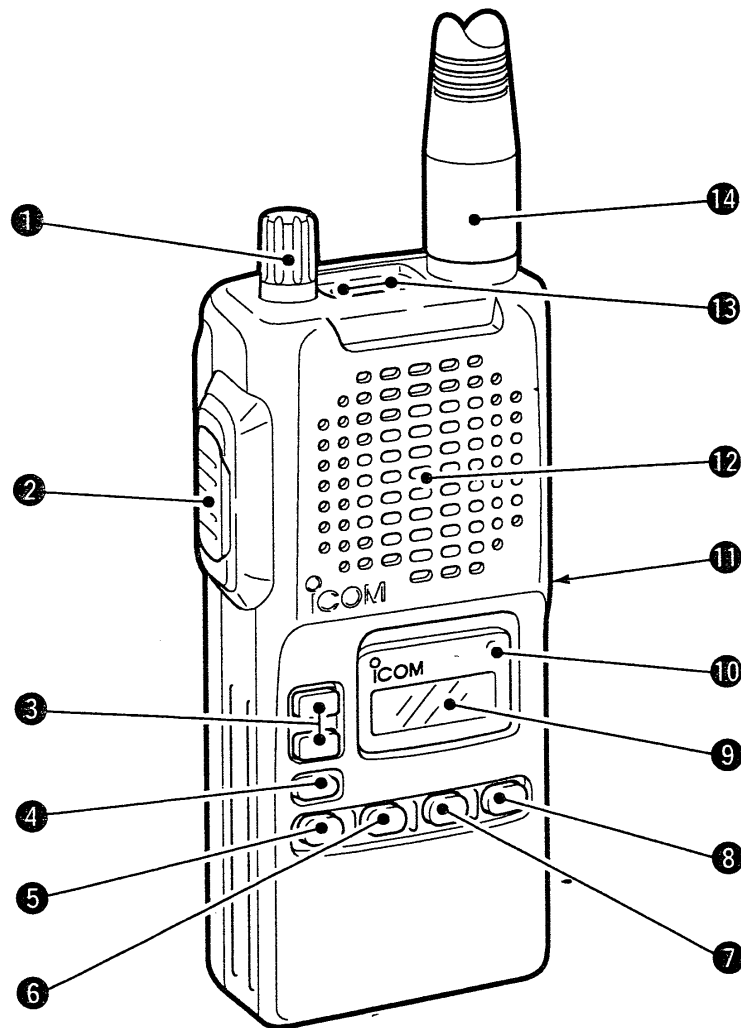

- 1 VOLUME CONTROLS [VOL]** (p. 5)  
 Turns power ON and adjusts the audio level.
- 2 PTT SWITCH [PTT]** (p. 5)  
 Push and hold to transmit; release to receive.
- 3 CHANNEL UP/DOWN SWITCHES [▲]/[▼]**  
 ➔ Push to select the operating channel or frequency. (p. 5)  
 ➔ Select item conditions in set mode.
- 4 LOCK SWITCH [🔒]**  
 ➔ Push and hold 2 sec. to toggle the key lock function ON or OFF. (p. 6)  
 - “🔒” appears on the display.
- 5 VFO/MEMORY SWITCH [V/M]**  
 ➔ Push to select VFO mode or memory mode. (pgs. 5, 8)  
 - “ME” appears when memory mode is selected.  
 - The transceiver has 19 memory channels.
- 6 MEMORY WRITE SWITCH [MW]**  
 ➔ Push and hold for 5 sec. to write information into memory channels. (p. 9)
- 7 SCAN SWITCH [SCAN]**  
 ➔ Starts and stops the scan function:  
 VFO mode: VFO scan function.  
 MEMORY mode: Memory channel scan function. (p. 10)

➔ When memory mode is selected, this switch sets the displayed channel as a scan lock-out channel when pushed for 2 sec. (p. 8)

- "SKIP" appears on the display.

### 8 SQUELCH SWITCH [SQL]

➔ Push and hold to open the squelch. (p. 6)

➔ While pushing [SQL], push [▲]/[▼] to select the squelch level. (p. 6)

- 9 squelch levels and squelch open are available.

### 9 FUNCTION DISPLAY (p. 4)

### 10 TRANSMIT INDICATOR

Lights red while transmitting.

### 11 EXTERNAL DC POWER JACK [CHARGE]

Connect a 12 to 16 V DC power source using the optional cables, CP-12L or OPC-254L, to charge the attached battery pack; or connect the BC-110V wall charger for charging.

 **CAUTION:** This connection is for charging ONLY. Power to the transceiver must be turned OFF during charging.

### 12 SPEAKER/MICROPHONE

### 13 EXTERNAL SPEAKER AND MICROPHONE JACKS [SP/MIC]

➔ Connect an optional speaker-microphone or headset, if desired. The internal microphone and speaker will not function when either is connected. (See p. 18 for a list of available options.)

➔ Side tone function is available when an optional headset adapter is connected. (pgs. 6, 18)

### 14 ANTENNA CONNECTOR (p. 1)

Connects the supplied antenna.

## 2 PANEL DESCRIPTION

### ■ Function display

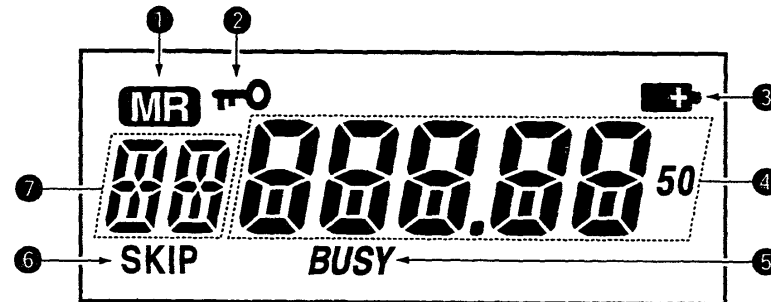

**① MEMORY MODE INDICATOR** (p. 9)

Appears when memory mode is selected.

**② LOCK INDICATOR** (p. 6)

Indicates that the lock function is in use.

**③ LOW BATTERY INDICATOR**

- Appears when the battery is nearing exhaustion.
- Appears and flashes when battery replacement is necessary.

**④ FREQUENCY DISPLAY** (p. 11)-

- Shows the operating frequency.
- Shows the channel name when the memory name function is selected. (p. 10)

**⑤ BUSY INDICATORS**

- "BUSY" appears when receiving a signal or when the squelch is open.

**⑥ MEMORY LOCKOUT INDICATOR**

- "SKIP" appears when the memory channel is set as lockout channel.

**⑦ MEMORY CHANNEL INDICATOR**

- Shows the memory channel number.
- When the transceiver output power increases above a specified level, a protection circuit stops the transmitting, then "--" appears on the display instead of the memory channel number. Release [PTT] then push it again to continue transmitting.



## ■ Receiving and transmitting

**CAUTION:** Transmitting without an antenna may damage the transceiver.

- ① Rotate [VOL] clockwise to turn power ON, then set to the 10 o'clock position.
- ② Push [V/M] to select memory mode or VFO mode.
- ③ Select the desired memory channel or VFO frequency with the [▲]/[▼] keys.
  - When receiving a signal, "BUSY" appears and audio is emitted from the speaker.
  - Further adjustment of [VOL] may be necessary at this point.
  - Push [SQL] to toggle the squelch function ON and OFF. (p. 6)
  - When the dial select function is selected, each push increments/decrements the frequency either 100 kHz or 1 MHz. (p. 7)
- ④ Push and hold [PTT] to transmit, then speak into the microphone.
  - Transmit indicator lights.
- ⑤ Release [PTT] to receive.

### ◇ Memory ⇒ VFO

Memory channel contents can be moved to VFO .

- ① Select memory channel to be transferred:
  - ➔ Push [V/M] to select memory mode, if necessary.
  - ➔ Push [▲] or [▼] to select the memory channel.

- ② Push [V/M] key for 2 sec. to transfer the memory contents to VFO.
  - VFO mode is selected

### NOTE:

- Only frequency data is transferred even if the memory channel has a memory name.
- When the preprogrammed memory frequency is outside the range of the preprogrammed VFO edges, an error beep tone sounds and no data is transferred.

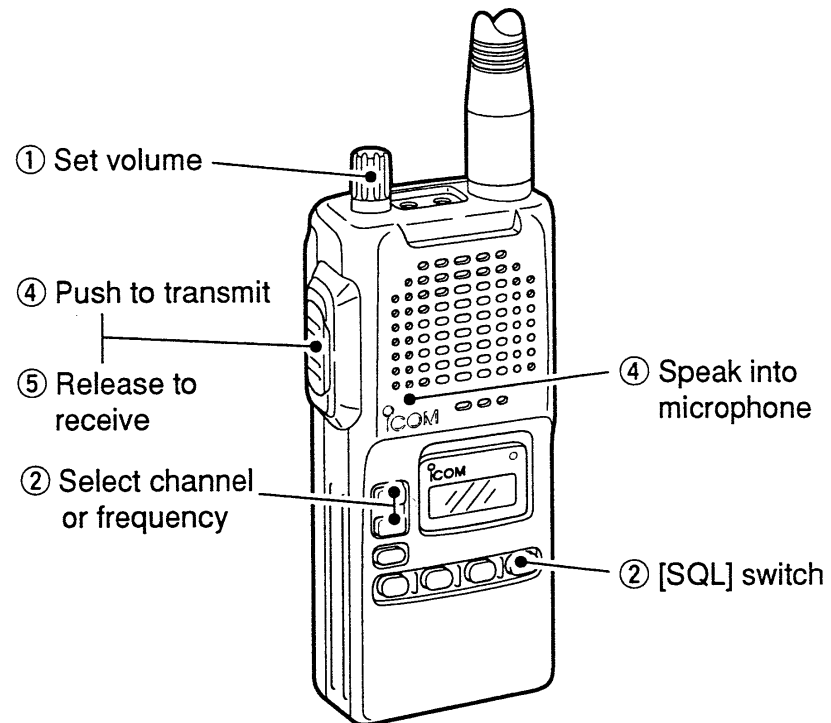

## 3 BASIC OPERATION

### ■ Setting squelch level

The transceiver has a noise squelch circuit to mute undesired noise while receiving no signal.

➔ *To open the squelch:*

Push and hold [SQL] to open the squelch. This is useful to listen to weak signals that do not open the squelch.

- "BUSY" appears on the display.

➔ *To close the squelch:*

Release [SQL] to close the squelch.

#### ◇ Setting the squelch level

① While pushing [SQL], push [▲] or [▼] to select the squelch level.

- 'Sq 1' is loose squelch and 'Sq 9' is tight squelch. (Initial level is 3.)

- 'oPEN' indicates that the squelch circuit is turned off.

② Release [SQL] to return to regular operation.

### ■ Side tone function

When using an optional headset, such as those from the David Clark Co. via the OPC-752 HEAD SET ADAPTOR, the transceiver outputs your transmitted voice to the headset for monitoring. (p. 18)

### ■ Lock function

The lock function prevents accidental channel changes and accidental function access. [PTT] and [SQL] still function while the lock function is in use.

➔ Push [ ] for 2 sec. to toggle the lock function ON and OFF.

"LO" appears when the lock function is in use.

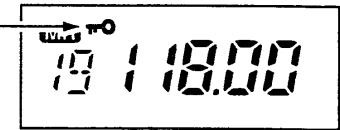

### ■ Display backlighting

Display backlighting automatically turns on when a key is pushed.

### ■ Low battery indicator

Low battery indicator appears when the battery power has decreased to a specified level.

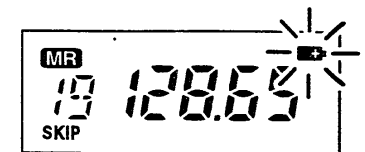

## ■ Dial select function

Use the dial select function to adjust the tuning behavior of the [▲]/[▼] keys—use 1 MHz tuning when you want to change the frequency in large increments; use regular tuning when you want to change the frequency in smaller increments.

- ① Push [V/M] to select VFO mode.
- ② Push [V/M] for 2 sec. one or more times to select the desired tuning increment.
  - 1 MHz tuning, 100 kHz tuning or regular tuning steps can be selected. (see diagrams at right)
- ③ Push any key to return to normal operation.

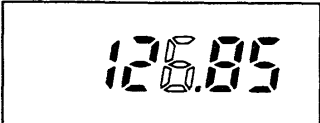

1 MHz tuning selected

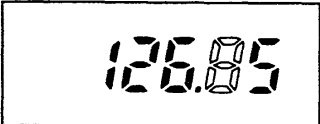

100 kHz tuning selected

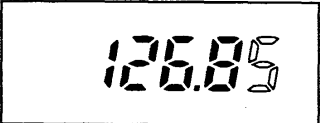

Regular tuning selected

**NOTE:** Large tuning steps should be used only when you want to change the frequency in large increments please select regular tuning steps for normal operation.

# 4

## SCAN OPERATION

### ■ Memory (lockout) scan

Memory scan repeatedly scans all programmed memory channels, except those set as *lockout* channels.

- ① Push [V/M] to select memory mode, if necessary.
  - “MR” appears.
- ② Push [SCAN] to start scan.
  - To change the scan direction, push [▲] or [▼].
- ③ Push [SCAN] again to stop the scan.

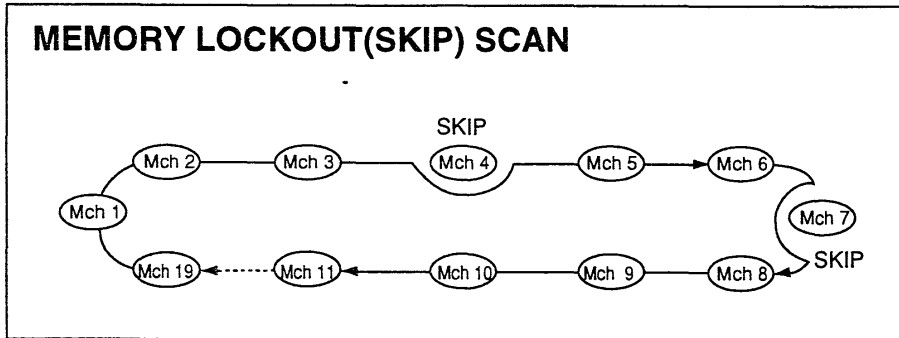

### ■ VFO (Full) scan

VFO scan repeatedly scans between the VFO's lowest frequency and its highest frequency.

- To change the scan direction, push [▲] or [▼] during scanning.

#### ◇ Scan resume condition

When a signal is received during scanning, the scan pauses on the signal until it disappears, then resumes.

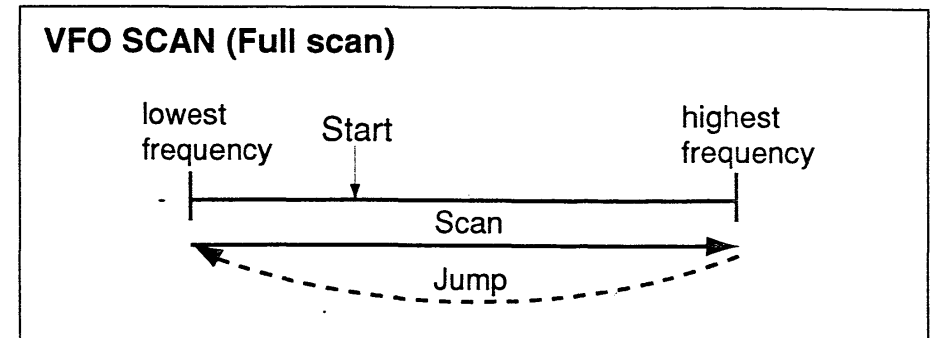

## ■ Programming a memory channel

The transceiver has 19 memory channels for storage of often-used frequencies.

- ① Push [V/M] to select VFO mode, if necessary.
- ② Push [▲] or [▼] key to select the desired frequency.
  - Push [V/M] key one or more times to use the dial select function, if desired.
- ③ Push [MW] for 5 sec. to enter memory programming mode.
  - “MR” and memory channel number appear.
- ④ Push [▲] or [▼] to select the desired memory channel number.
- ⑤ Push [MW] for 2 sec. to program the information into the channel and return to VFO mode.

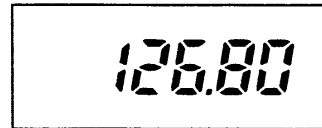
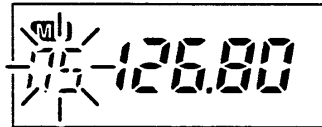
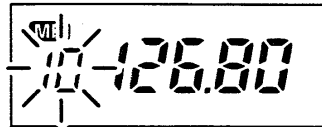
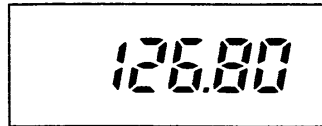

## ◇ Setting lockout channels

In order to speed up the scan interval, you can set memory channels you don't wish to scan as lockout channels.

- ① Push [V/M] to select memory mode, if necessary.
  - “MR” appears.
- ② Push [▲] or [▼] to select a memory channel to set as a lockout channel.
- ③ Push [SCAN] for 2 sec. to toggle the lockout setting ON/OFF.
  - “SKIP” appears when the channel is set as a lockout channel.
  - If memory channel scan is accidentally started, push [SCAN] to stop it.

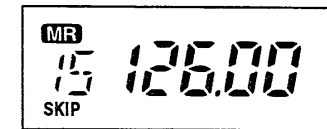

Memory channel 15 is set as a lockout channel.

## 5 MEMORY PROGRAMMING

### ■ Memory names

#### ◆ Programming memory names

- ① Select the memory channel to be programmed:
  - ➔ Push [V/M] to select memory mode.
  - ➔ Push [▲] or [▼] to select the memory channel.
- ② Push [M/W] for 5 sec. to enter memory name writing mode.
  - The first character of the name flashes.
- ③ Push [SCAN] or [SQL] as many times as necessary to enter the desired name.
  - To erase a character, overwritet with a space (displayed as \_).
  - To move the cursor forwards or backwards, use [▲] or [▼].
  - Push [●] for 2 sec. to erase all characters.
- ④ Push [M/W] to input the set name.
  - Flashing stops.
  - Memory channels can be programmed with names of up to 5 characters in length.
  - When no name is programmed, the display shows the operating frequency.

• The following characters can be used in names:

➔ 0 to 9, A to Z (capitals), (space), "-", #, \$, &, (, ), ", ', ?, ! and @.

[EXAMPLE]: Setting the name to "TOWER".

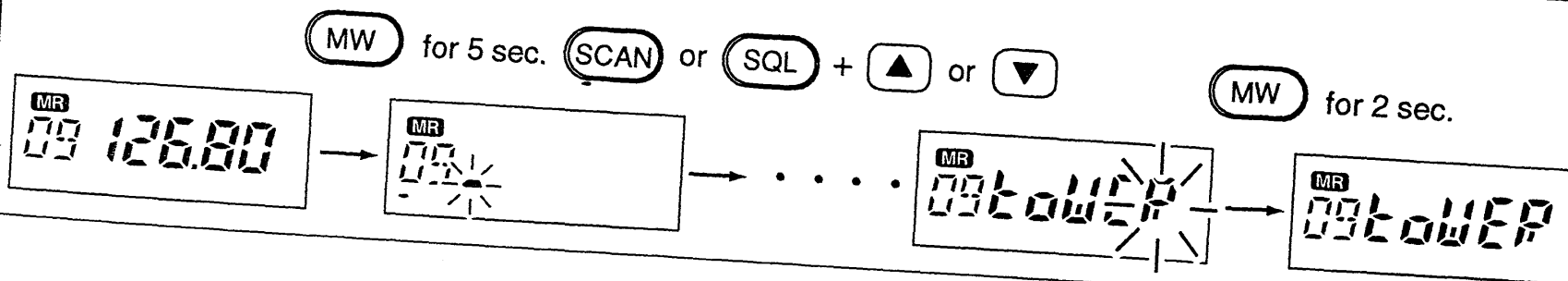

## ■ Initial set mode

AT POWER ON

Initial set mode is accessed at power ON and allows you to set seldom-changed settings, in this way you can “customize” transceiver operations to suit your preferences and operating style.

### ◇ Entering initial set mode

- ① While pushing [V/M] + [POWER], turn power ON.
  - The transceiver enters initial set mode and “mn”, “bP” or “St” appears on the display.
- ② Push [▲] or [▼] one or more times to select the desired item as described below and at right.
- ③ Push [POWER] to select the desired condition.
- ④ Push [MW] or [PTT] to exit initial set mode and select the previous operating mode.

### ◇ Memory names

This item allows you to display a memory name instead of frequency.

- When a memory channel has not been programmed with a name, frequency indication appears instead.

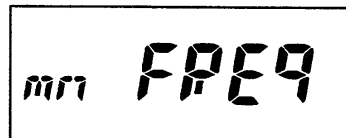
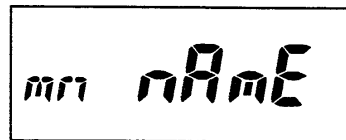

### ◇ Beep tones ON/OFF

Confirmation beep tones normally sound when you push a key. These can be turned ON or OFF as you prefer.

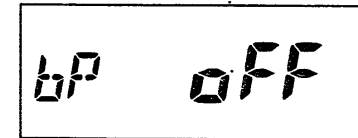

### ◇ Side tones ON/OFF

When using an optional headset such as those from the David Clark Co. via the adapter, the transceiver outputs your transmitted voice to the headset for monitoring.

- Optional **OPC-752 HEADSET ADAPTER** is required.

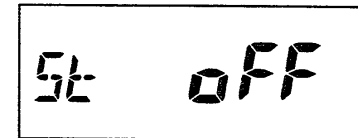
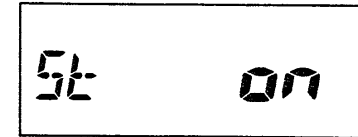

## ■ Resetting the CPU

Reset the CPU before operating the transceiver for the first time, or when the internal CPU malfunctions.

- ➔ While pushing [V/M] + [MW] + [SCAN], turn power ON to reset the transceiver.
  - “CLEAR” appears briefly to indicate the CPU has been reset.

## ■ Charging precautions

**NEVER** attempt to charge dry cell batteries. This will cause internal liquid leakage and damage the battery case and transceiver.

**NEVER** connect two or more chargers at the same time.

Charging may not occur under temperatures of 10°C (50°F) or over temperatures of 40°C (104°F).

**When using BC-119:** If the charge indicator flashes orange, vehicle battery voltage is low and charging is not possible. Check the vehicle battery voltage in this case. If the charge indicator flashes red, there may be a problem with the battery pack (or charger). Re-insert the battery pack or contact your dealer.

## ■ Battery pack charging

The BP-195 or BP-196 BATTERY PACK includes rechargeable Ni-Cd batteries and can be charged approx. 300 times. Charge the battery pack before first operating the transceiver or when the battery pack becomes exhausted.

If you want to be able to charge the battery pack more than 300 times, the following points should be observed:

1. Avoid overcharging. The charging period should be less than 48 hours.
2. Use the battery until it becomes almost completely exhausted under normal conditions. We recommend battery charging just after transmitting becomes impossible.

## ◇ Rapid charging with the BC-119

The optional BC-119 provides rapid charging of battery packs.

One AD-81 and an AC adapter (may be supplied with the BC-119 depending on version) are additionally required.

- **Charging periods:** 1.5 hours (w/BP-195)  
2 hours (w/BP-196)

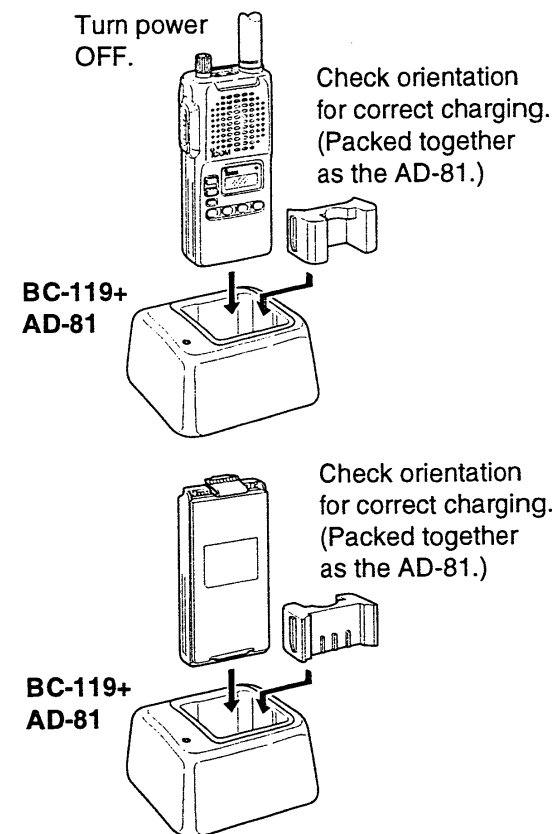



## ◆ Multiple charging with the BC-121

The optional BC-121 allows up-to 6 battery packs to be charged simultaneously.

Six AD-81's and an AC adapter (may be supplied with the BC-121 depending on version) are additionally required.

- Charging periods: 1.5 hours (w/BP-195)
- 2 hours (w/BP-196)

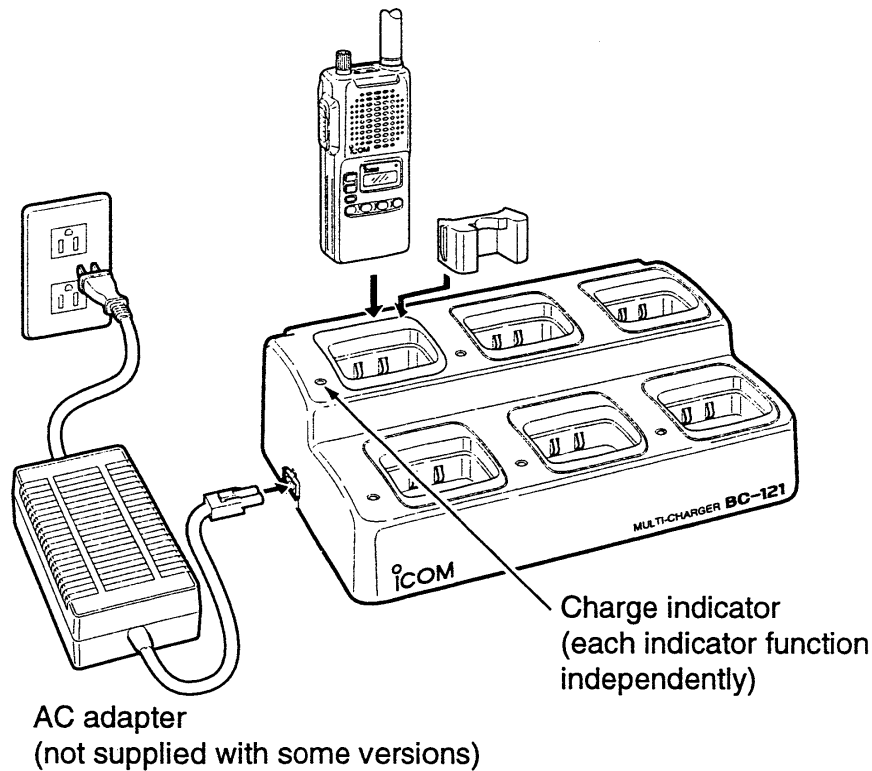

## ◆ Regular charging

- ① Attach the battery pack to the transceiver.
- ② Be sure to turn the transceiver power OFF.
- ③ Connect the AC adapter (BC-110A/D/V) or optional cable (CP-12L or OPC-254L) as shown below.

- Charging periods: 10 hours (w/BP-195)
- 15 hours (w/BP-196)

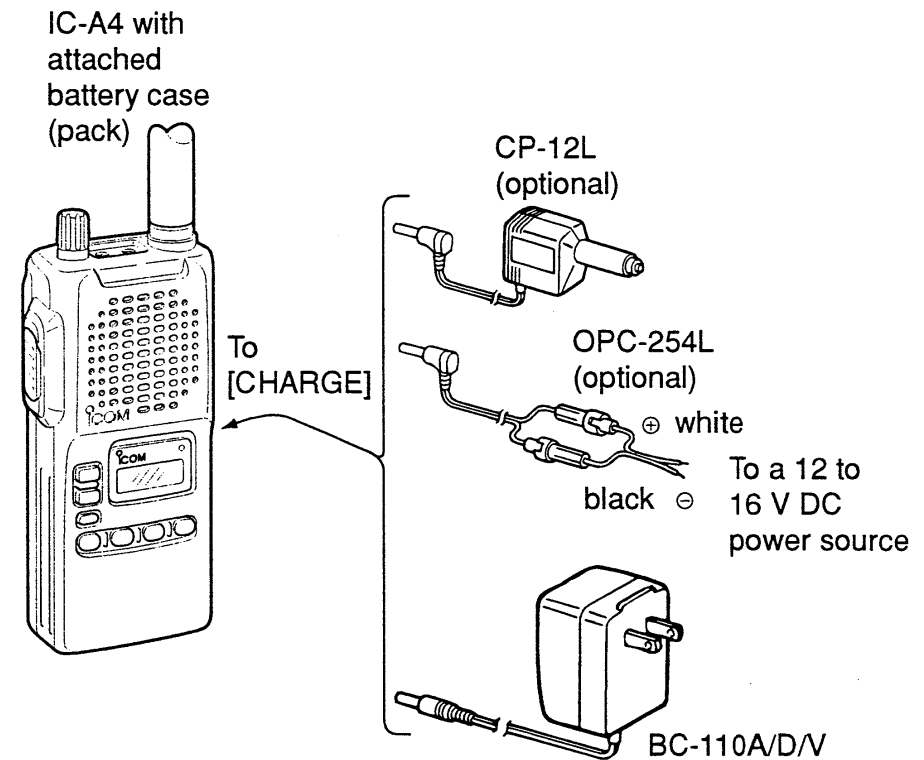

## 7 BATTERY PACKS

### ■ About the battery pack

#### ◇ Operating period

Depending on the attached battery pack, the operating period of the transceiver varies. Refer to the last page for battery pack specifications.

#### ◇ Battery pack life

If your battery pack seems to have no capacity even after being fully charged, completely discharge it by leaving the power ON overnight. Then, fully charge the battery pack again.

If the battery pack still does not retain a charge (or very little), a new battery pack must be purchased.

#### ◇ Recycling information (U.S.A only)



The product that you have purchased may contain a rechargeable battery. The battery is recyclable. At the end of its life, under various state and local laws, it may be illegal to dispose of this battery into the municipal waste stream. Call 1-800-8-BATTERY for battery recycling options in your area or contact your dealer.

### ■ Installing batteries in the battery case

When using a battery case, install 8 AA (R6) size Ni-Cd or alkaline batteries as illustrated below.

- ① Remove the battery case from the transceiver.

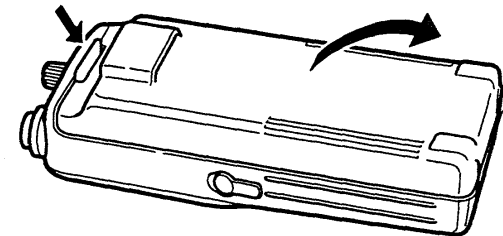

- ② Install 8 × AA (R6) size Ni-Cd or alkaline batteries.
  - Be sure to observe the correct polarity.

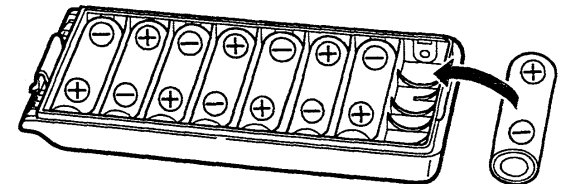

- **NEVER** connect DC power to the transceiver when installing dry cell or alkaline batteries. Such a connection will damage the transceiver.
- Be careful of battery overcharging. When operating via external DC power, installed batteries are simultaneously charged.
- Keep battery contacts clean. It's a good idea to clean battery terminals once a week.

Cloning allows you to quickly and easily AT POWER ON transfer the programmed contents from one transceiver to another transceiver, or, data from PC to a transceiver using the optional EX-2119 cloning software.

## ◇ Transceiver to transceiver cloning

- ① Connect the OPC-474 CLONING CABLE with adapter plugs to the [SP] jack of the master and slave transceivers.
  - The master transceiver is used to send data to the slave transceiver.
- ② While pushing [▲] + [▼] + [V/M], turn power ON to enter cloning mode (master transceiver only—power ON only for slave transceiver).
  - “CLonE” appears and the transceivers enter the clone standby condition.
- ③ Push [PTT] on the master transceiver.
  - “CLoUt” appears in the master transceiver’s display.
  - “CL in” appears automatically in the slave transceiver’s display.
- ③ When cloning is finished, turn power OFF, then ON again to exit cloning mode.

CLonE

CLoUt

CL In

## ◇ Cloning using PC

Data can be cloned to and from a PC (IBM compatible) using the optional EX-2119 CLONING SOFTWARE and the optional OPC-478 CLONING CABLE. Consult the EX-2119 CLONING SOFTWARE HELP message for details.

## ◇ Cloning error

**NOTE: DO NOT** push [PTT] on the slave transceiver during cloning. This will cause a cloning error.

When the display at right appears, a cloning error has occurred.

CLEAR

In this case, both transceivers automatically return to the clone standby condition and cloning must be repeated.

# 9

## TROUBLESHOOTING

If your transceiver seems to be malfunctioning, please check the following points before sending it to a service center.

PROBLEM	POSSIBLE CAUSE	SOLUTION	REF.
No power comes on.	<ul style="list-style-type: none"> <li>• The battery is exhausted.</li> <li>• Bad connection to the battery pack.</li> </ul>	<ul style="list-style-type: none"> <li>• Recharge the battery pack.</li> <li>• Check the connection to the transceiver.</li> </ul>	pgs. 12, 14
No sound comes from the speaker.	<ul style="list-style-type: none"> <li>• Squelch level is too deep.</li> <li>• Volume level is too low.</li> </ul>	<ul style="list-style-type: none"> <li>• Set squelch to the threshold point.</li> <li>• Set [VOL] to a suitable level.</li> </ul>	pgs. 5, 6
Transmitting impossible.	<ul style="list-style-type: none"> <li>• Some channels are receive only.</li> <li>• The battery is exhausted.</li> </ul>	<ul style="list-style-type: none"> <li>• Change channels.</li> <li>• Recharge the battery pack.</li> </ul>	p. 5 p. 12
The displayed channel cannot be selected.	<ul style="list-style-type: none"> <li>• Lock function is activated.</li> </ul>	<ul style="list-style-type: none"> <li>• Push  for 2 sec. to cancel the function.</li> </ul>	p. 6
Scan does not start.	<ul style="list-style-type: none"> <li>• All memory channels are programmed as lockout channels.</li> </ul>	<ul style="list-style-type: none"> <li>• Cancel the lockout settings of desired channels.</li> </ul>	p. 9
No beep sounds.	<ul style="list-style-type: none"> <li>• Beep tones turned OFF.</li> </ul>	<ul style="list-style-type: none"> <li>• Turn the beep tone ON in set mode.</li> </ul>	p. 11

## ◇ General

- Frequency coverage : TX 118 to 136.975 MHz  
RX 108 to 136.975 MHz
- Mode : AM (6K00A3E)
- Number of memory channels : 19
- Acceptable power supply : 9.6 V DC nominal  
(negative ground) (authorized battery packs)
- Usable temp. range : -10°C to +50°C
- Frequency stability : ±10 ppm (0°C to +50°C)
- Current drain :  
Tx 1.2 A (CW) max.  
0.7 A (CW) typical  
Rx 55 mA typical (at stand by)  
250 mA max. (at AF max.)
- Antenna impedance : 50 Ω (nominal)
- Dimensions : 58(W)×140.5(H)×32.3(D) mm  
(projections not incl.)
- Weight (with BP-195) : 425 g

## ◇ Transmitter

- Output power : 3.7 W (PEP) typical  
1.0 W (CW) typical
- Modulation : Low level modulation
- Modulation limiting : 80 to 100 %
- Audio harmonic distortion : Less than 10 %  
(at 60 % modulation)
- Hum and noise ratio : More than 35 dB
- Spurious emissions : More than 60 dB

## ◇ Receiver

- Receive system : Double conversion  
superheterodyne
- Intermediate frequencies : 1st 28.95 MHz  
2nd 450 kHz
- Sensitivity (with 50 Ω load) : 1 μV (at AM 6dB S/N)
- Squelch sensitivity : 1 μV  
(with 50 Ω load)
- Selectivity : 8 kHz (at 6 dB)  
25 kHz (at 60 dB)
- Spurious response : More than 60 dB
- Audio output power : 500 mW (at 10% distortion  
at 9.6 V DC) with an 8 Ω load)
- Noise and hum : More than 25 dB
- External SP connector : 3-conductor 3.5 (d) mm/8 Ω

All stated specifications are subject to change without notice or obligation.

# 11 OPTIONS

## ◇ Battery packs

Battery pack	Voltage	Capacity	Charging period		Operating period* <sup>1</sup>
			Wall charger	BC-119 or BC-121 with AD-81	
<b>BP-194</b>	Battery case for AA (R6) × 8 alkaline or Ni-Cd cells		10 hrs* <sup>2</sup>	N/A	6 hrs* <sup>2</sup>
<b>BP-195</b>	9.6 V	700 mAh	10 hrs	1.5 hrs	6 hrs
<b>BP-196</b>	9.6 V	1050 mAh	15 hrs	2.0 hrs	9.0 hrs

<sup>1</sup> Operating periods are calibrated for the following conditions:  
at 25°C (77°F), Tx (high power) : Rx : standby = 5 : 5 : 90

\*<sup>2</sup> When Ni-Cd batteries are installed.

## ◇ Other options

### **BC-110A/D/V** WALL CHARGER

Used for regular charging of the connected battery pack.

### **BC-119** DESKTOP CHARGER + **AD-81** CHARGER ADAPTOR

For rapid charging of battery packs. An AC adapter is supplied with the charger. Some BC-119 versions require the AD-75 additionally. Charging time: 1.5 to 2 hrs.

### **BC-121** MULTI-CHARGER + **AD-81** CHARGER ADAPTOR

For rapid charging up to 6 battery packs simultaneously. An AC adapter may be supplied depending on version. Six AD-81's are necessary. Charging time: 1.5 to 2 hrs.

### **OPC-254L** DC POWER CABLE

### **CP-12L** CIGARETTE LIGHTER CABLE WITH NOISE FILTER

Allows you to charge a battery pack connected to the transceiver via a DC power source (12–16 V DC) For charging ONLY—the transceiver cannot be simultaneously operated.

### **HM-119** SPEAKER MICROPHONE

Combination speaker and microphone.

### **SP-13** EARPHONE

Provides clear audio in noisy environments.

### **OPC-752** HEADSET ADAPTER

When using an optional headset, such as those from the David Clark Co. via the adapter, the transceiver outputs your transmitted voice to the headset for monitoring. (p. 19)

### **EX-2119** FIELD PROGRAMMING SOFTWARE

Provides quick and easy programming of items, including private channels, scan settings, etc., via an IBM® compatible PC to transceiver.

### **OPC-474** CLONING CABLE

Cloning cable for transceiver to transceiver.

### **OPC-478** CLONING CABLE

Cloning cable for PC to transceiver.

IBM® is a registered trademark of International Business Machines.

◇ **OPC-752 (HEADSET ADAPTER) connection**

When using an optional headset, such as those from the David Clark Co. via the adapter, the transceiver outputs your transmitted voice to the headset for monitoring. (pgs. 6, 11)

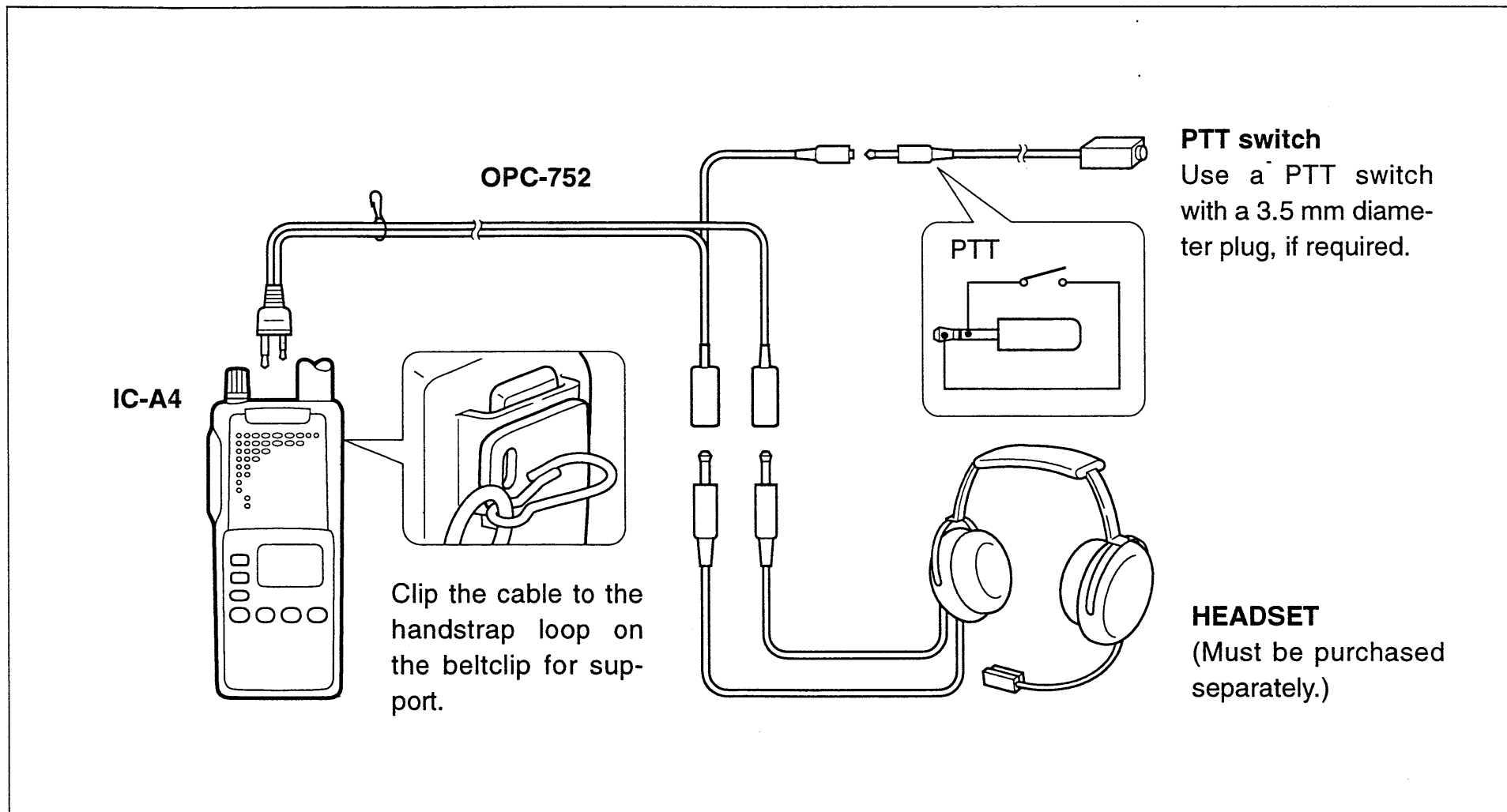

**Count on us!**

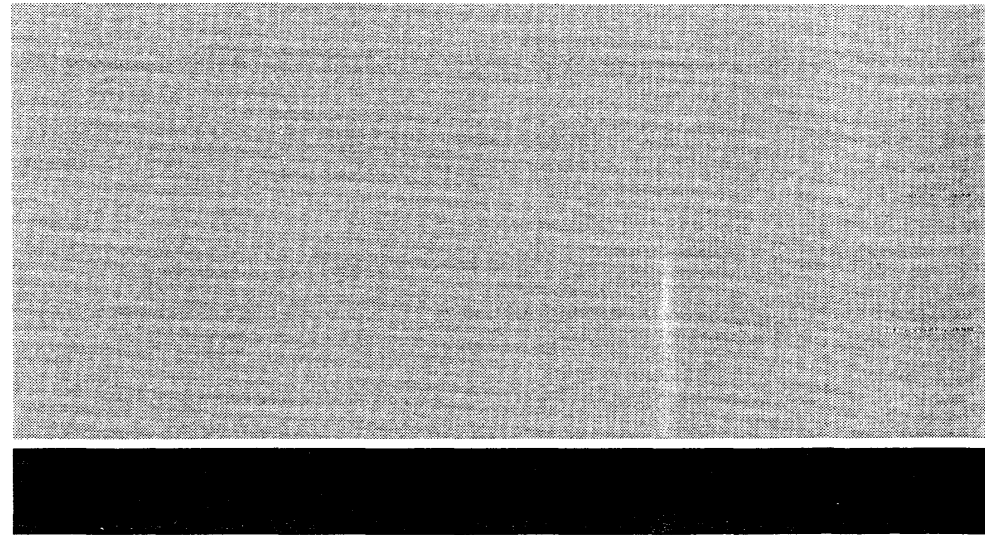

A-5493H-1EX  
Printed in Japan  
Copyright 1997 Icom Inc.

**Icom Inc.**  
6-9-16 Kamihigashi, Hirano-ku, Osaka 547 Japan